

DEMEX

INSTALLATION

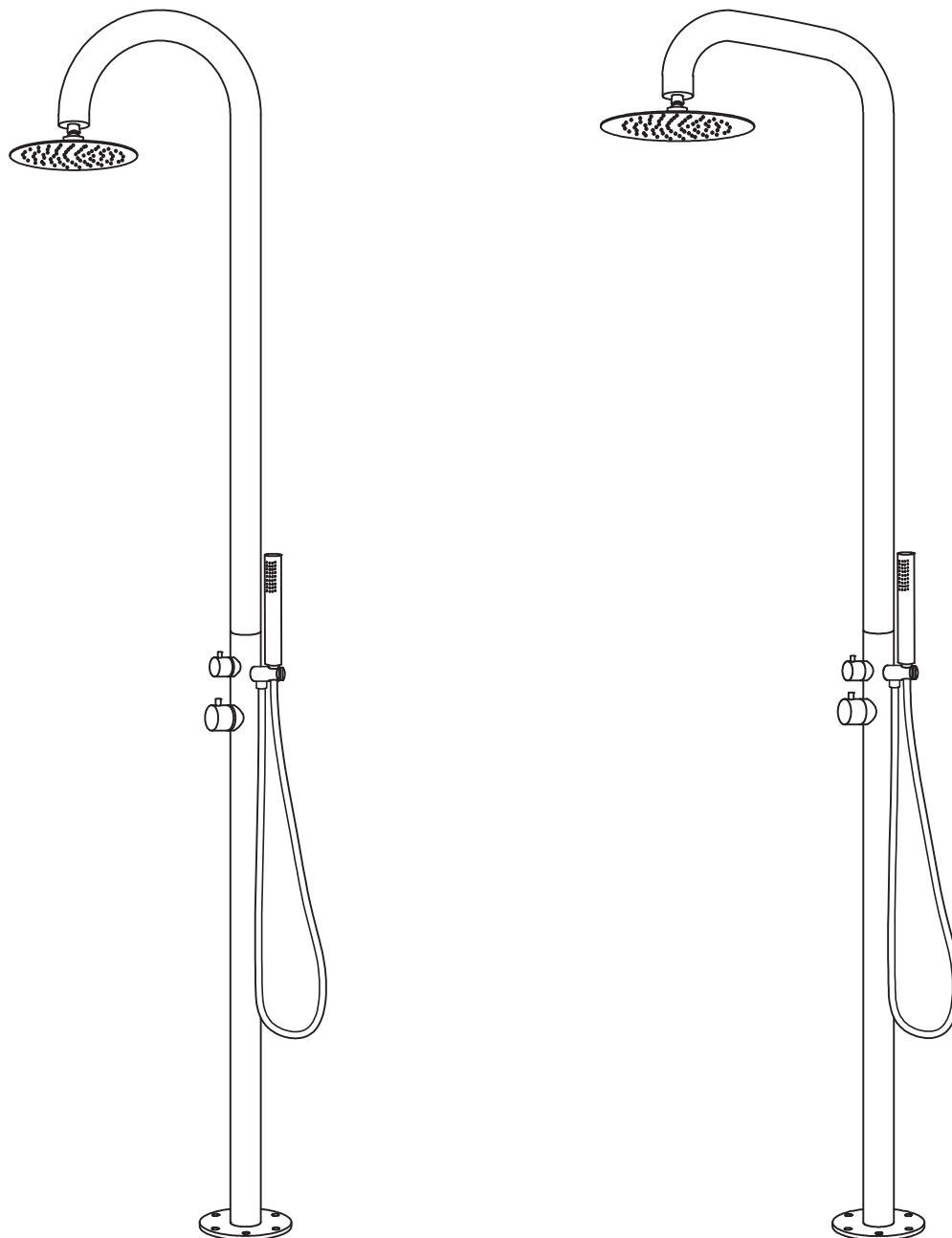

40030 / 40031

Utedusch i rostfritt stål

Stainless Steel Outdoor Shower

INSTALLATION

1

Före installationen behöver anslutning för inkommande vatten förberedas vid platsen där uteduschen ska stå.
Before installation, water supply lines must be prepared at the place where the outdoor shower will be standing.



Använd skyddshandskar.
Use protecting gloves.

a) Skruva fast bottenplattan på det nedre uteduschröret.
Screw the base plate onto the lower outdoor shower pipe.

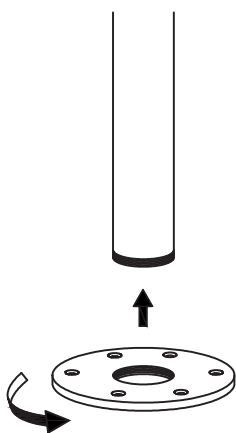

b) Borra hål och tryck in expansionskruvarna (medföljer).*
Drill holes and insert the expansion screws (included).*

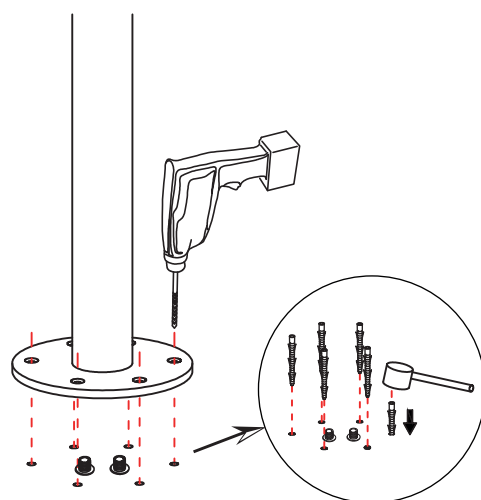

c) Anslut uteduschens vattenslangar till slangarna med inkommande kall- och varmvatten.
Connect the outdoor shower's water lines to the corresponding water supply lines.

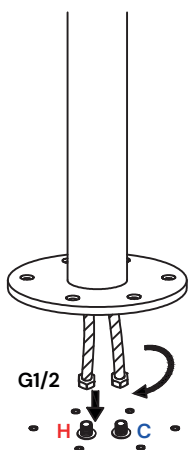

d) Skruva fast fixeringskruvarna ordentligt (medföljer).*
Tighten the fixing screws firmly (included).*

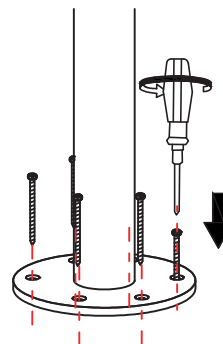

* Vid behov, använd andra lämpliga skruvar (medföljer ej).
* If needed, use other suitable screws (not included).

INSTALLATION

2

a) Koppla samman vattenslangarna mellan det nedre och övre uteduschröret.

Connect the water hoses between the lower and upper outdoor shower pipe.

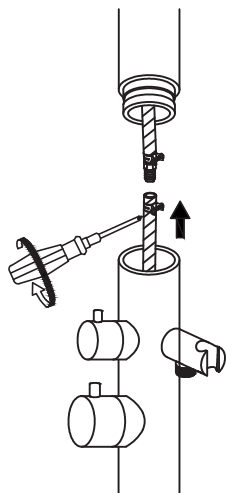

b) Skruva ihop det övre uteduschröret med det nedre.

Screw together the upper outdoor shower pipe with the lower one.



c) Lås fast rören med en insexnyckel.

Tighten the pipes with an Allen key.

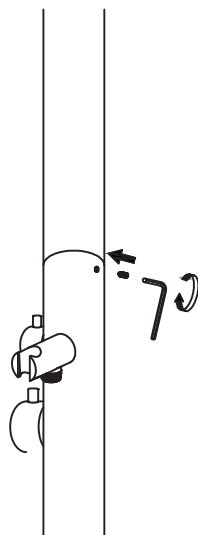

d) Montera takdusch och handdusch.

Fit the overhead shower and the shower head.

